

INSTRUÇÕES DE MONTAGEM
MESA CENTRO RETANGULAR 1 GAVETA

TOKYO

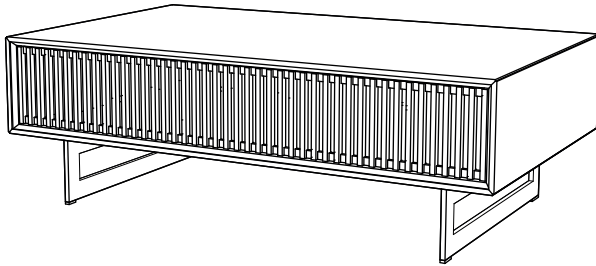

ANTARTE

design for life

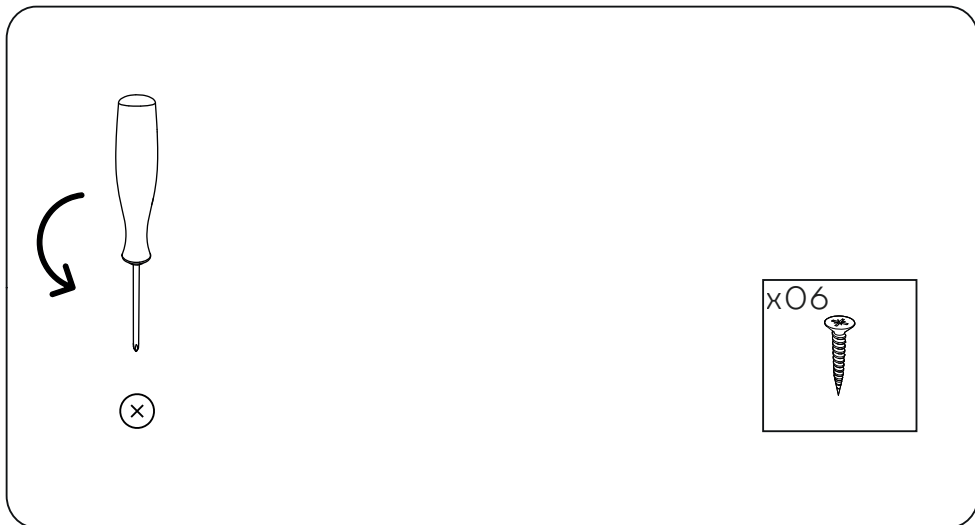

Obrigado pela sua preferência!

O design, a elegância e o conforto estão agora mais perto de si!



01

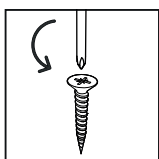
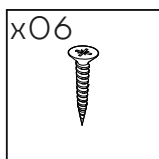
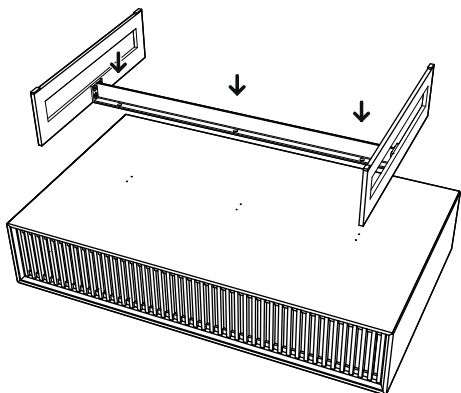

02

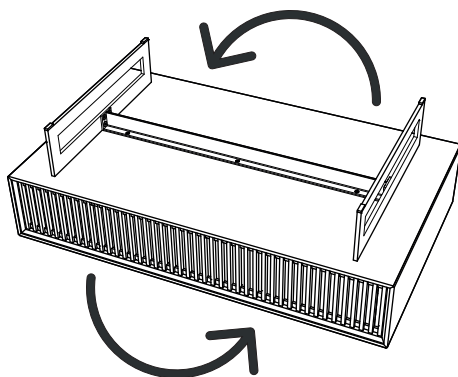

AFINAÇÃO DA GAVETA CORREDIÇA LADO ESQUERDO

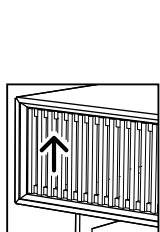
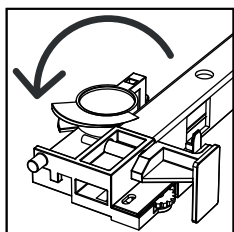
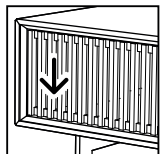
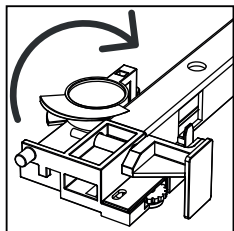

CORREDIÇA LADO DIREITO

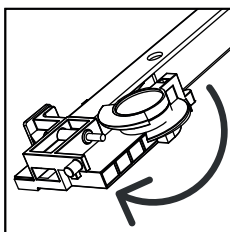
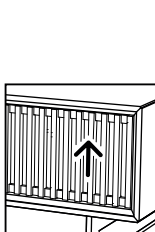
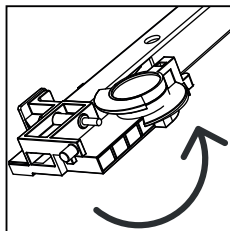
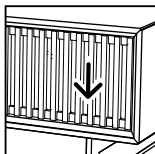



ANTARTE

design for life

SEDE:

AV. DA ZONA INDUSTRIAL, 222
4585-303 REBORDOSA

PAREDES, PORTUGAL

+351 224 119 350

(chamada para a rede fixa nacional)

ANTARTE@ANTARTE.PT

WWW.ANTARTE.PT