

INSTRUÇÕES DE MONTAGEM  
MÓVEL TV 3 PORTAS  
COM MÓDULO LACADO

MALMO

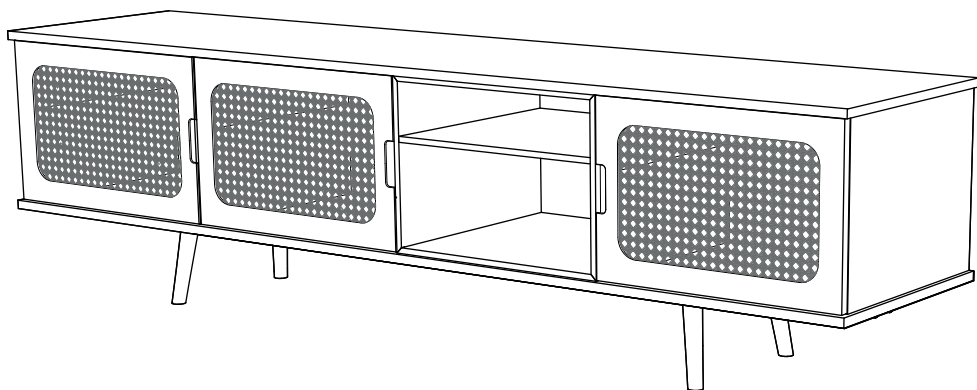

**ANTARTE**

design for life

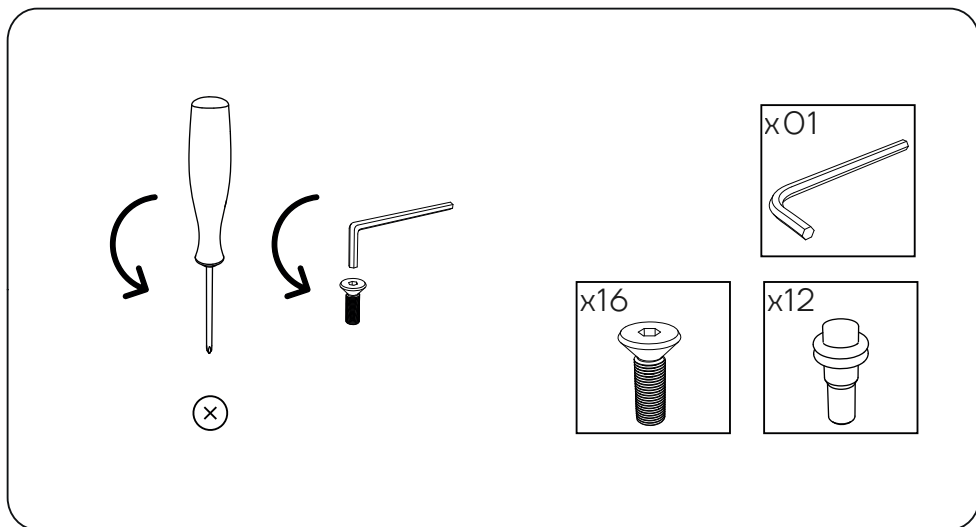

# Obrigado pela sua preferência!

O design, a elegância e o conforto  
estão agora mais perto de si!

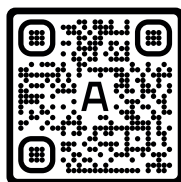

01

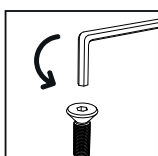
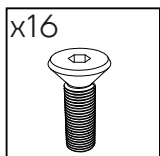
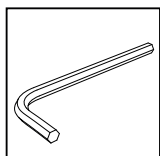
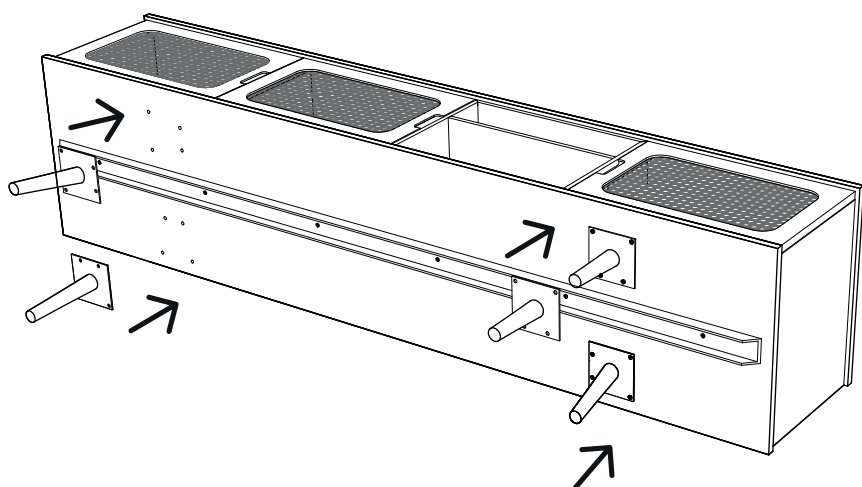

02

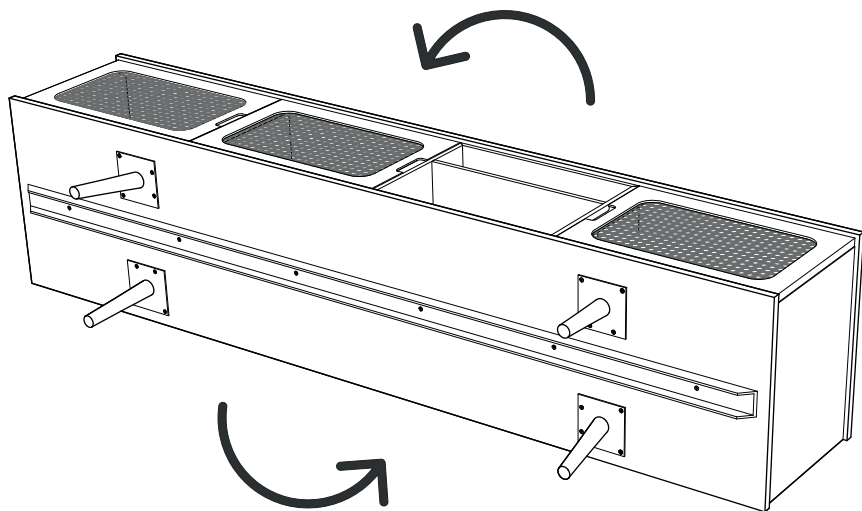

03

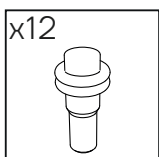
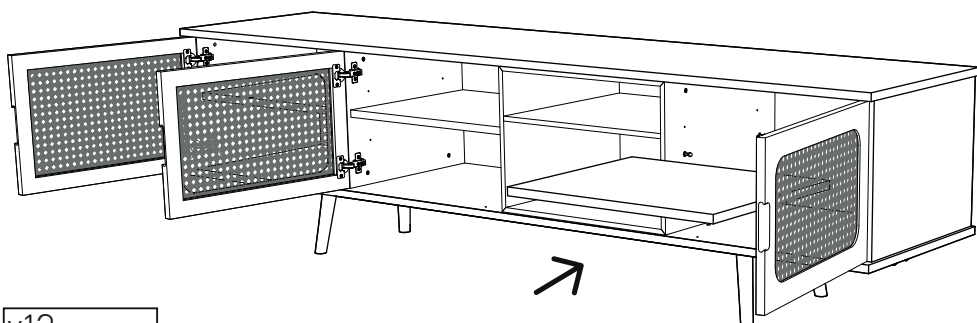

# AFINAÇÃO DA PORTA

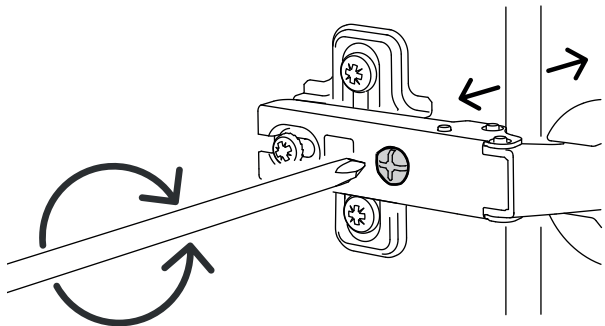
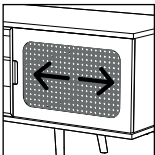
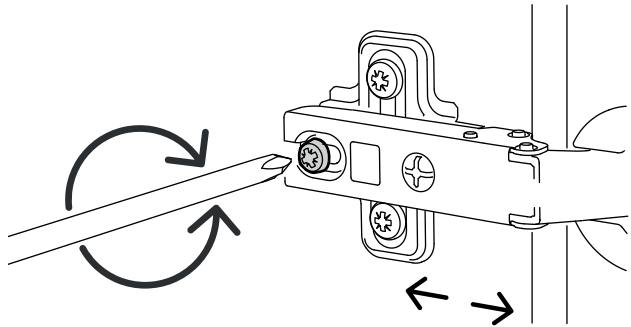
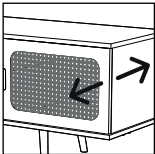
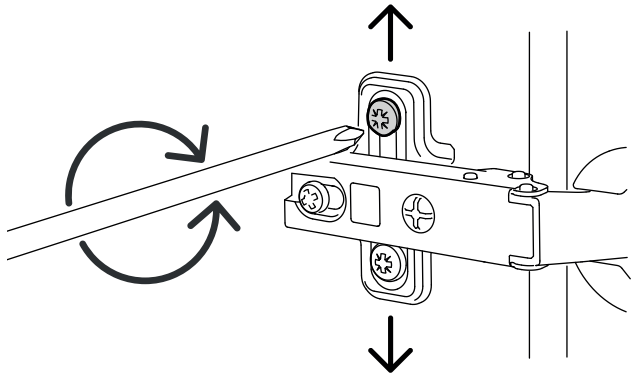
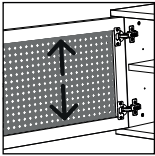



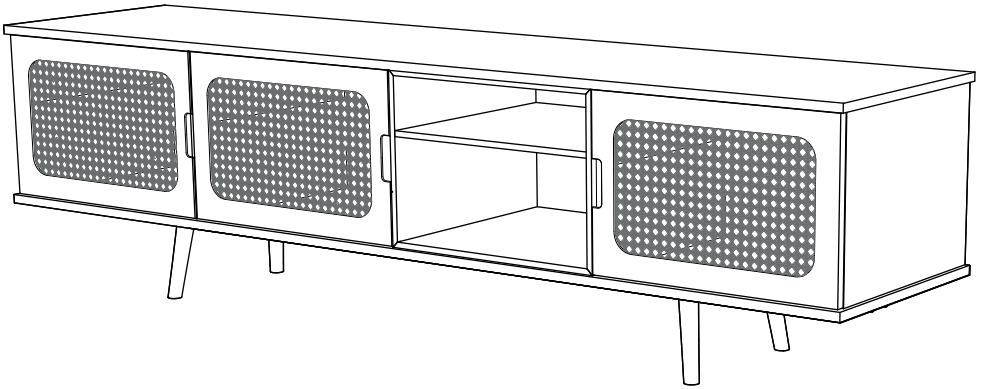



**ANTARTE**

design for life

SEDE:

AV. DA ZONA INDUSTRIAL, 222

4585-303 REBORDOSA

PAREDES, PORTUGAL

+351 224 119 350

(chamada para a rede fixa nacional)

[ANTARTE@ANTARTE.PT](mailto:ANTARTE@ANTARTE.PT)

[WWW.ANTARTE.PT](http://WWW.ANTARTE.PT)