

INSTRUÇÕES DE MONTAGEM
CAMA CASAL
COM BASE E ARRUMAÇÃO

MALMO

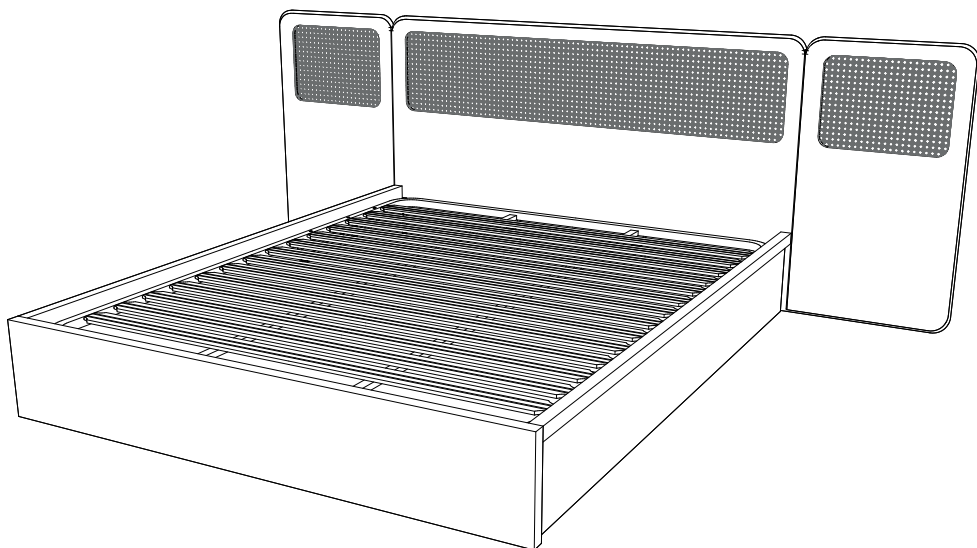

ANTARTE

design for life

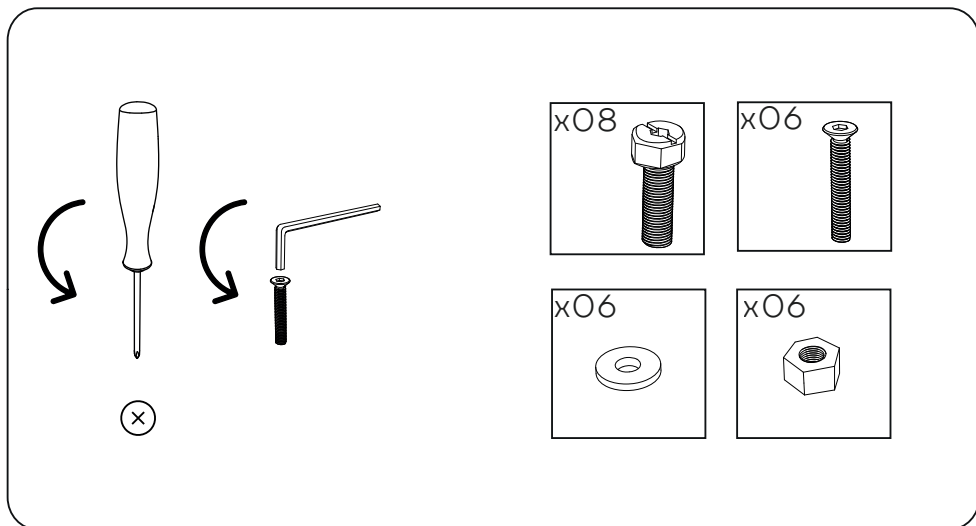

Obrigado pela sua preferência!

O design, a elegância e o conforto estão agora mais perto de si!

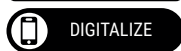
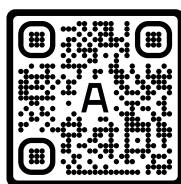

01

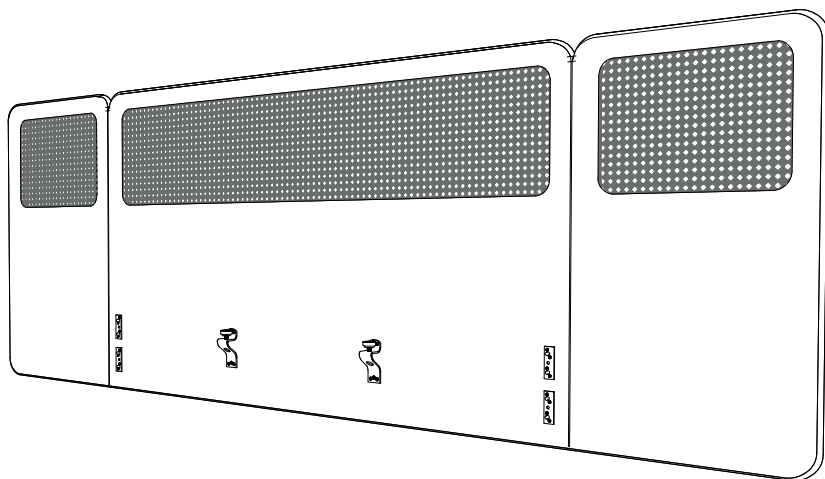

02

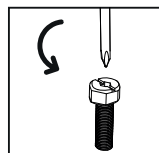
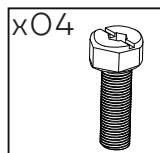
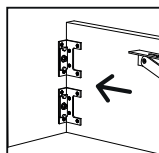
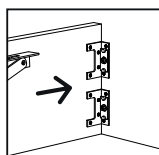
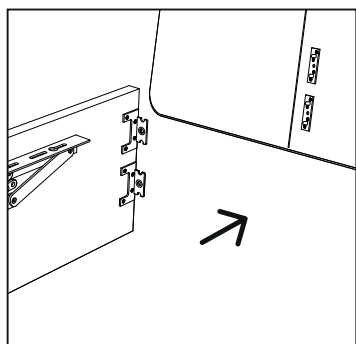
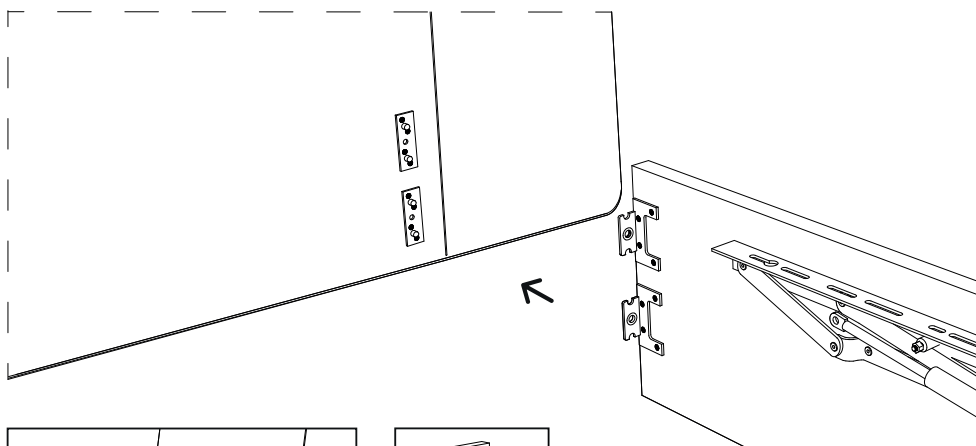

03

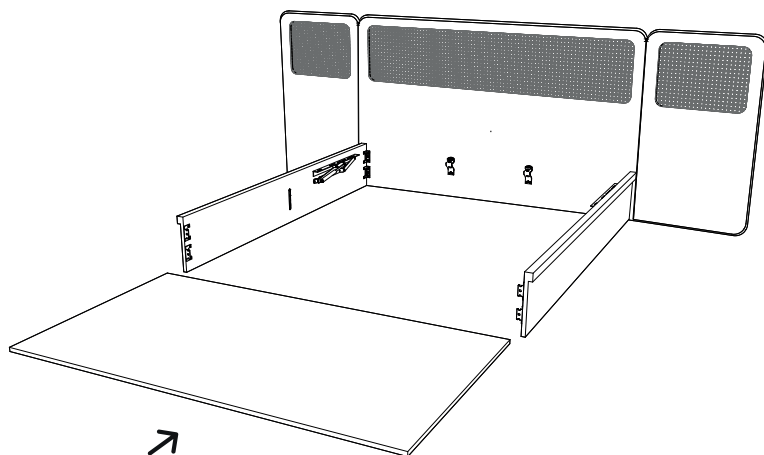

04

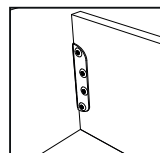
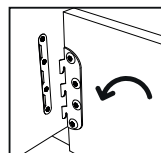
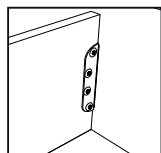
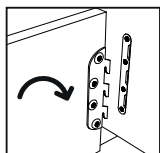
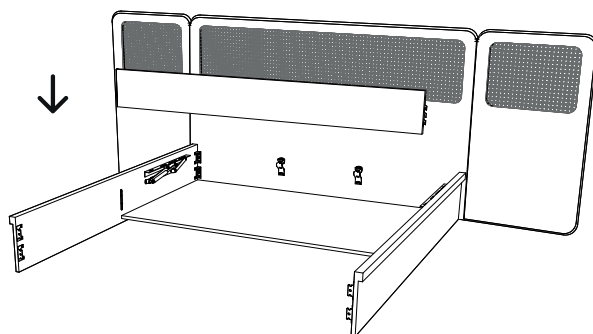

05

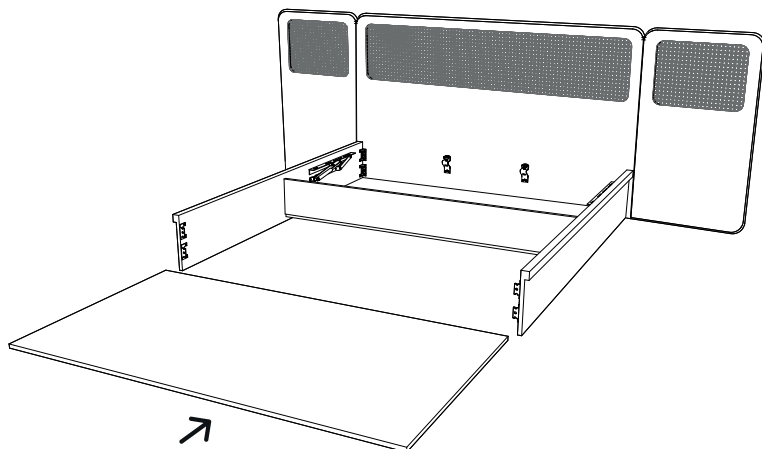

06

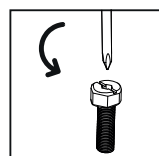
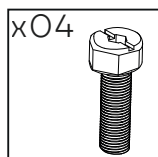
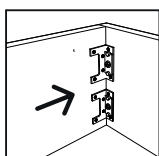
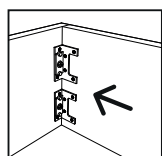
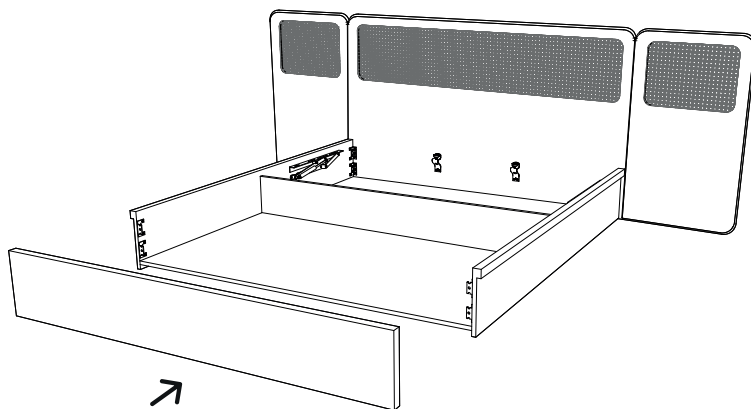

07

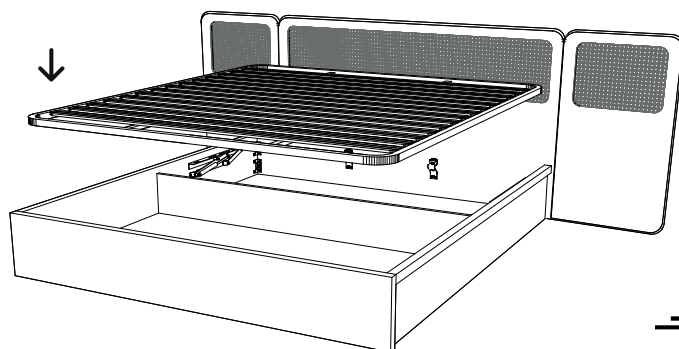

08

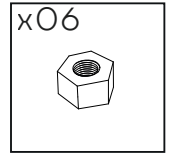
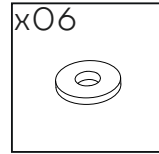
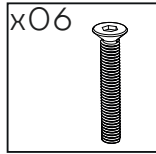
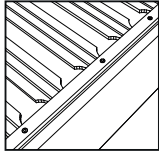
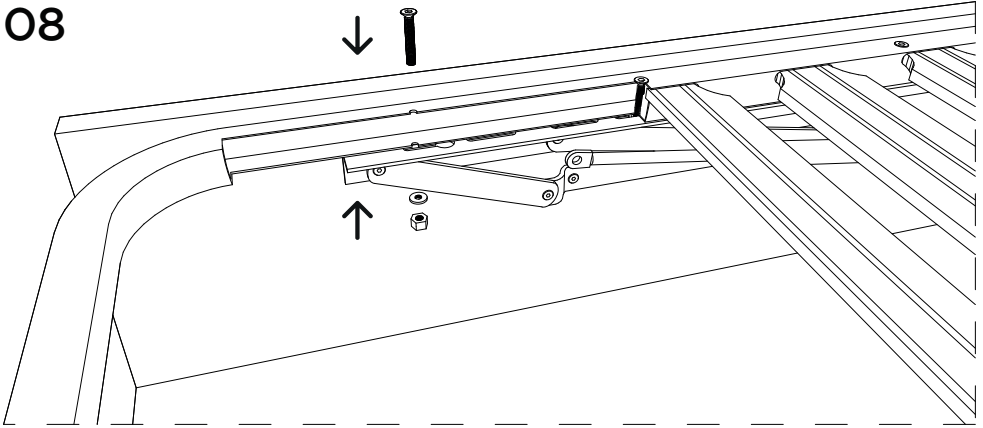

09

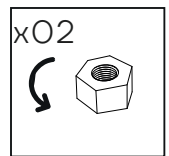
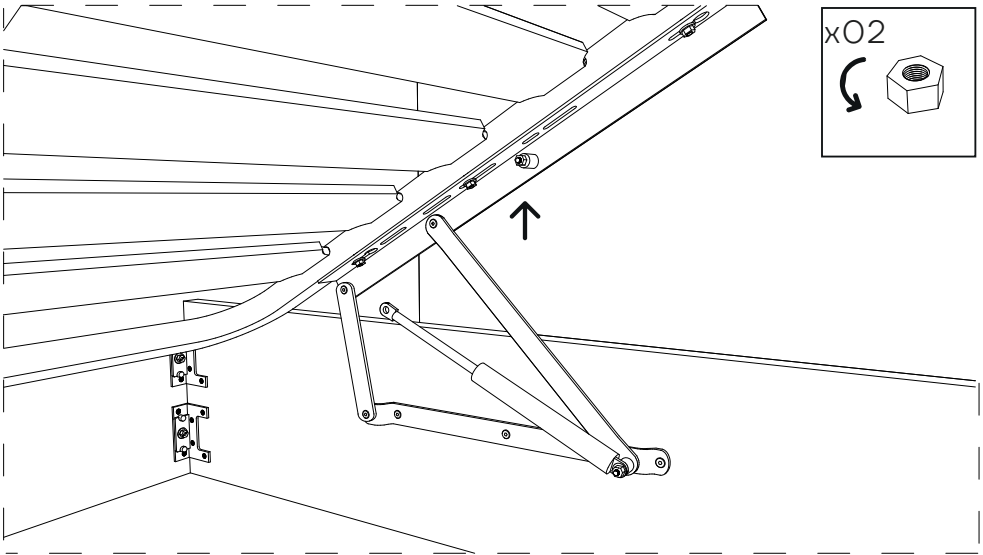

10

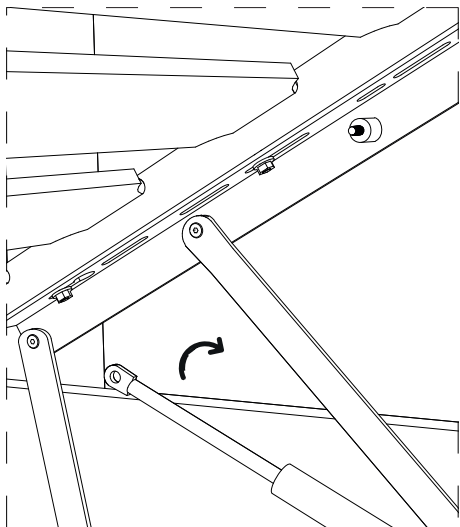

11

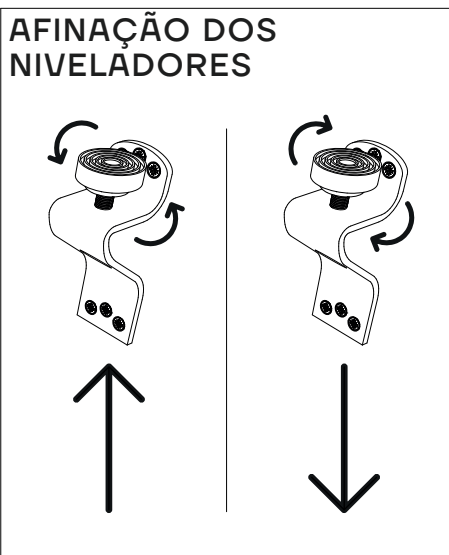
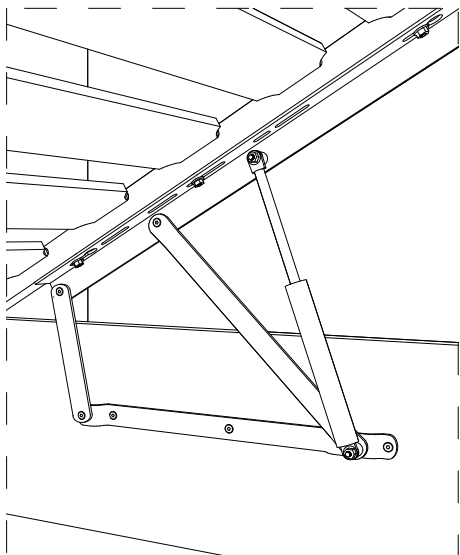
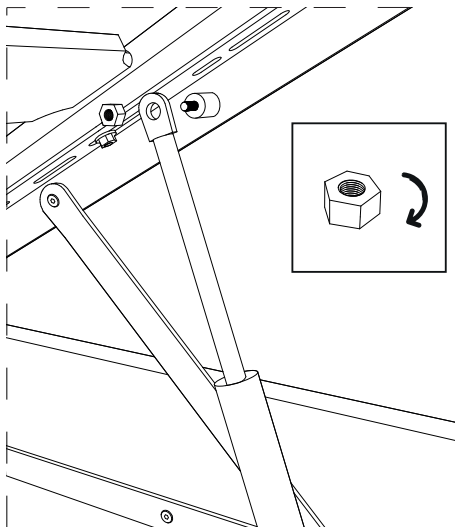



ANTARTE

design for life

SEDE:

AV. DA ZONA INDUSTRIAL, 222
4585-303 REBORDOSA

PAREDES, PORTUGAL

+351 224 119 350

(chamada para a rede fixa nacional)

ANTARTE@ANTARTE.PT

WWW.ANTARTE.PT