

INSTRUÇÕES DE MONTAGEM
CABECEIRA ESTOFADA
1500 / 1600 / 1700 / 1900

OPORTO

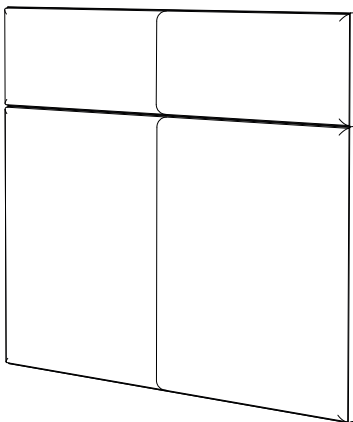

ANTARTE

design for life



Obrigado pela sua preferência!

O design, a elegância e o conforto
estão agora mais perto de si!

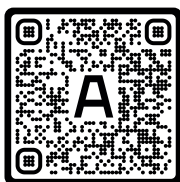

01

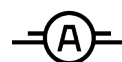
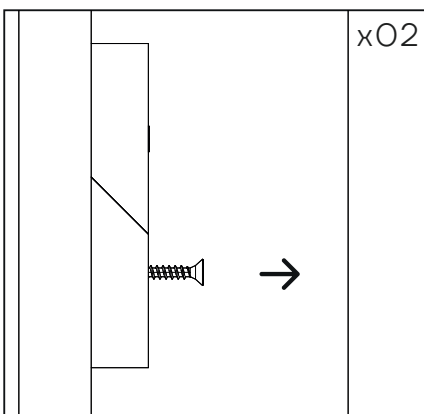
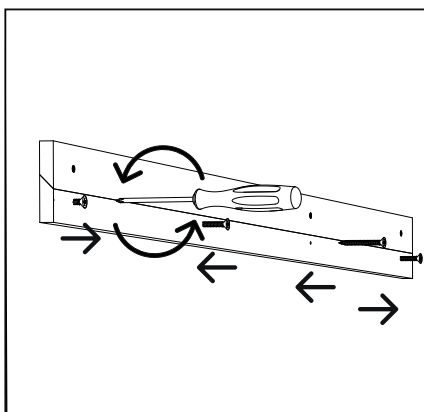
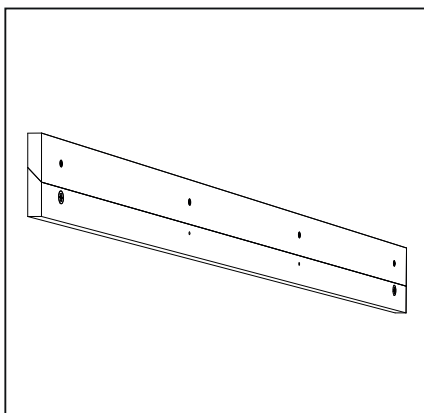

02

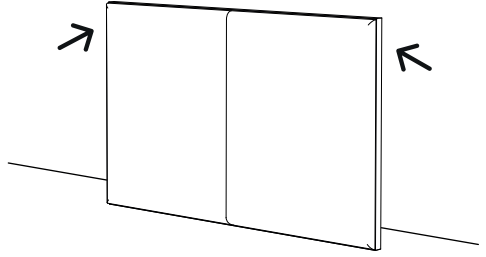
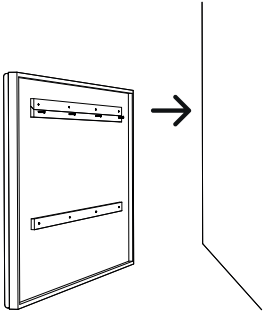

03

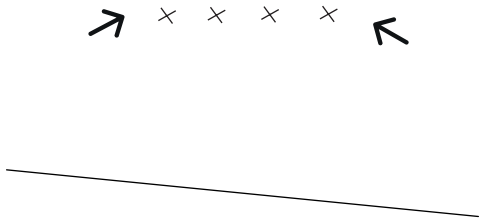
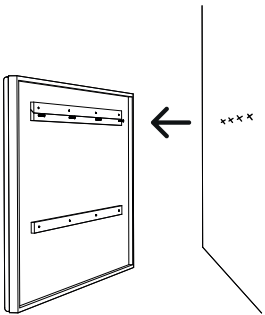

04

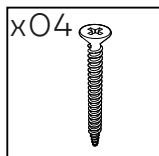
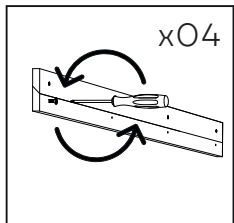
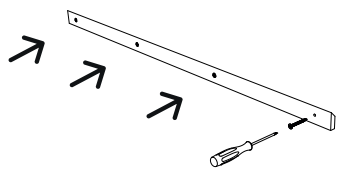

05

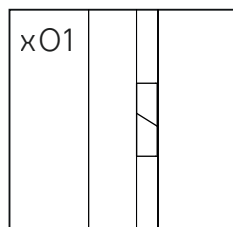
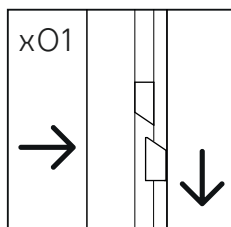
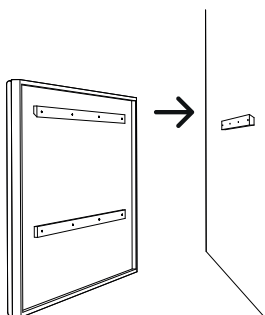

06

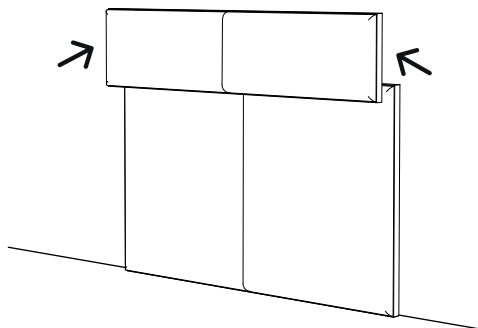
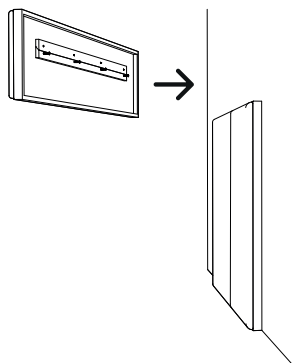

07

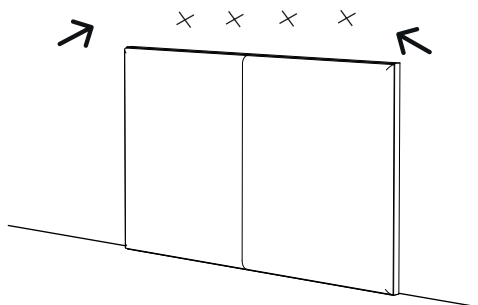
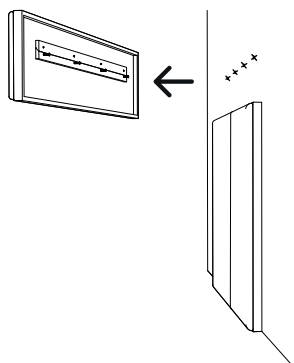

08

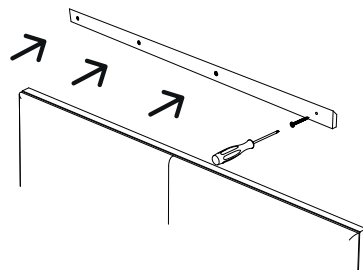
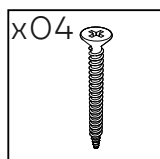
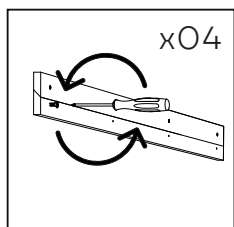

09

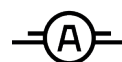
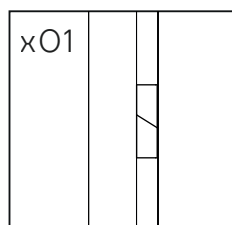
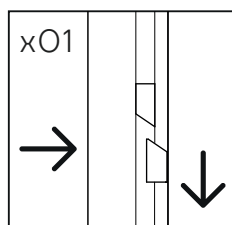
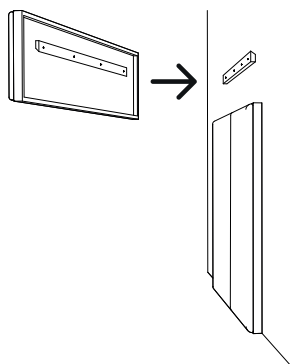



ANTARTE

design for life

SEDE:
AV. DA ZONA INDUSTRIAL, 222
4585-303 REBORDOSA
PAREDES, PORTUGAL
+351 224 119 350
(chamada para a rede fixa nacional)
ANTARTE@ANTARTE.PT
WWW.ANTARTE.PT