

INSTRUÇÕES DE MONTAGEM
**SOFA 3 LUGARES
COM CHAISE LONGUE**

OPORTO

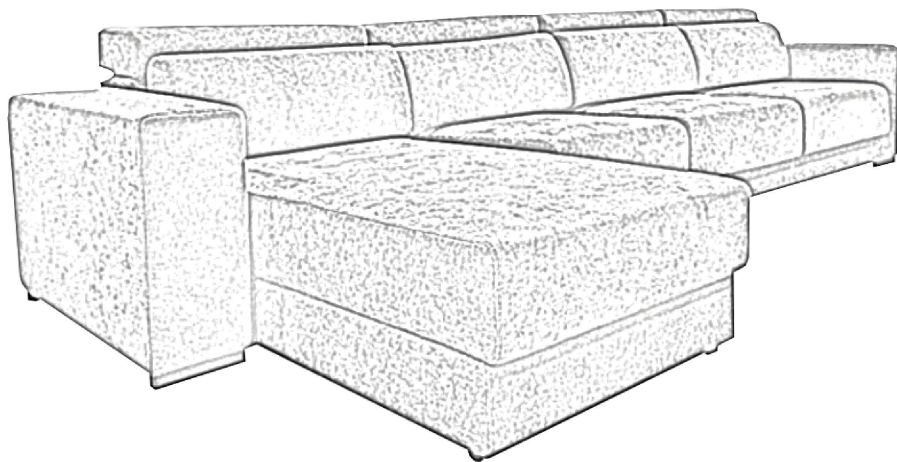

ANTARTE

design for life

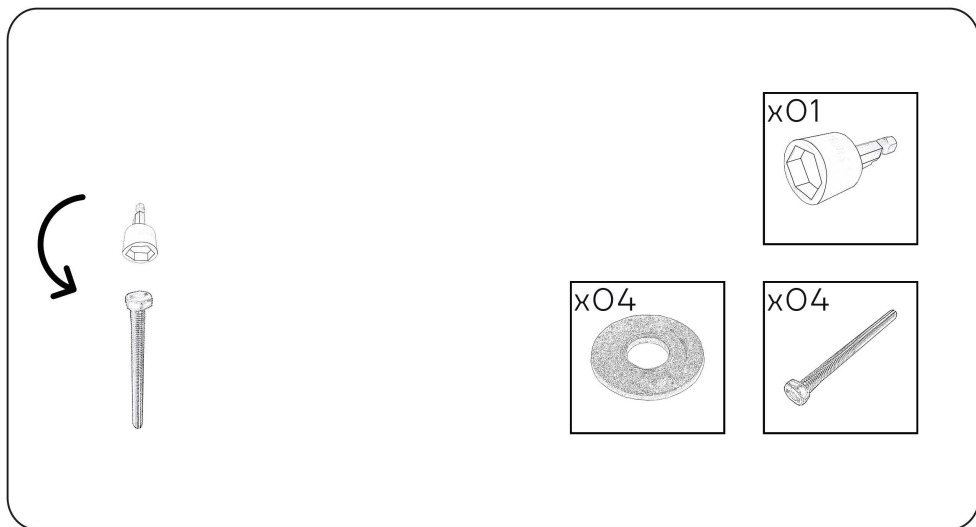

Obrigado pela sua preferência!

O design, a elegância e o conforto
estão agora mais perto de si!



01



02

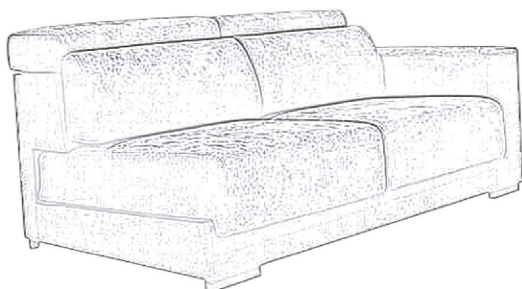

03

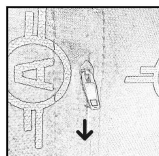
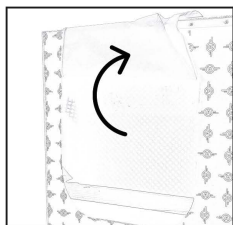
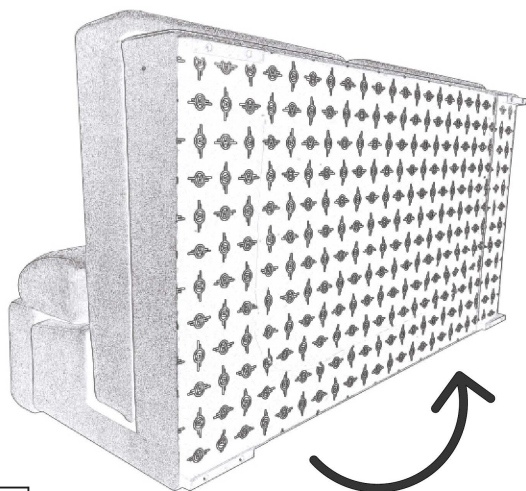

04

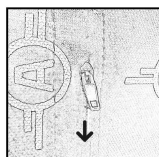
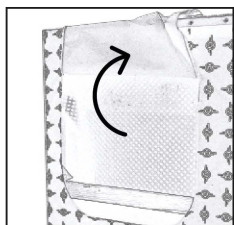
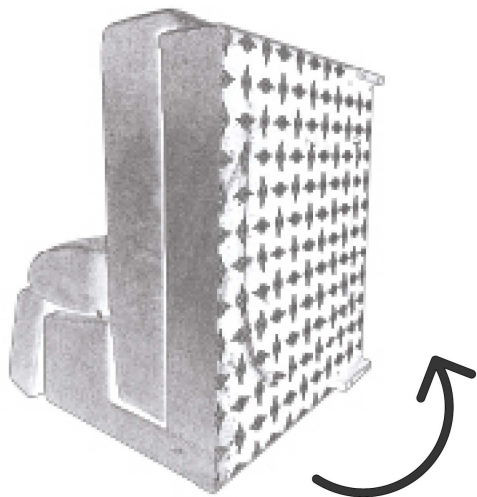

05

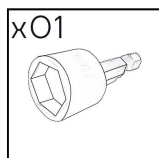
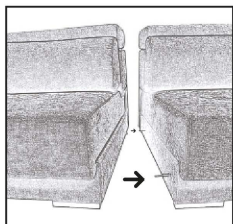
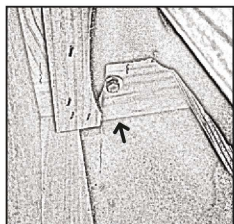
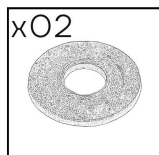
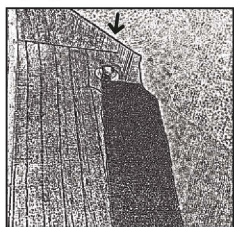

06

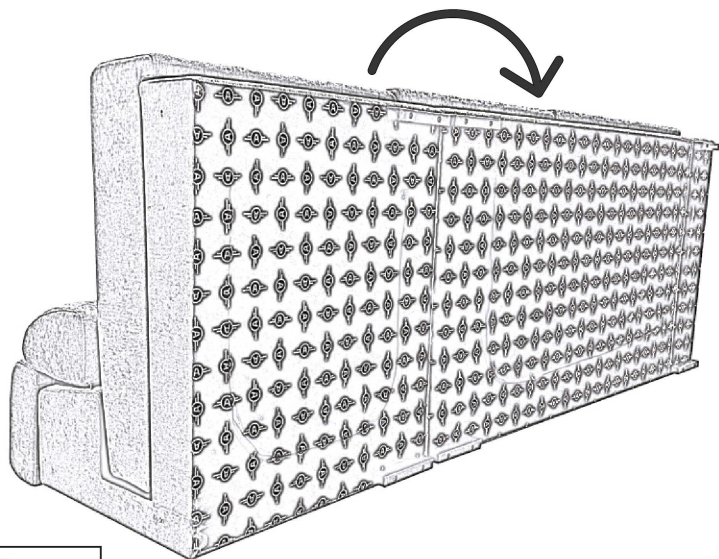
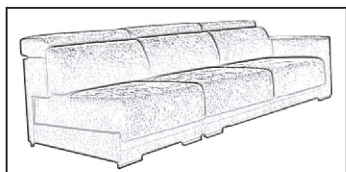
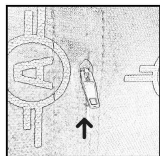
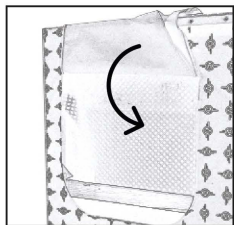

07



08

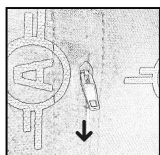
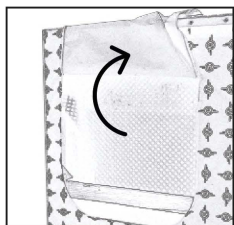
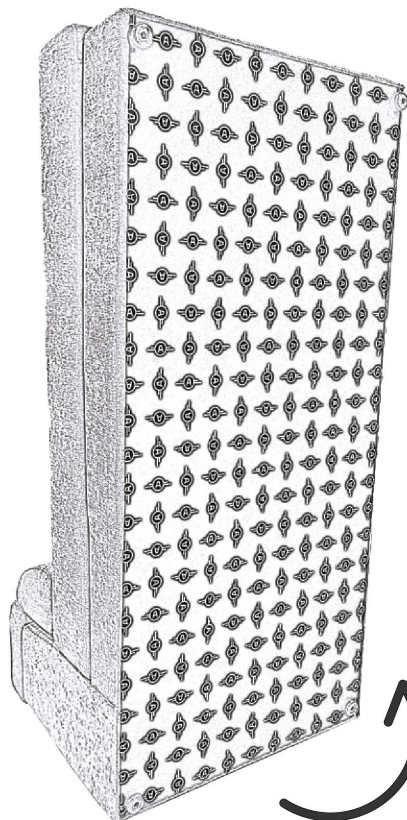

09

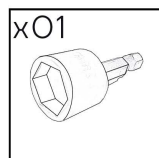
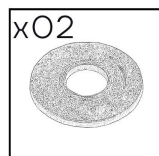
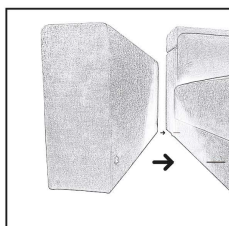
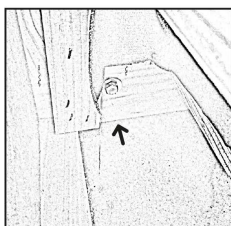
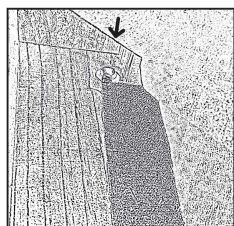

10

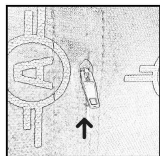
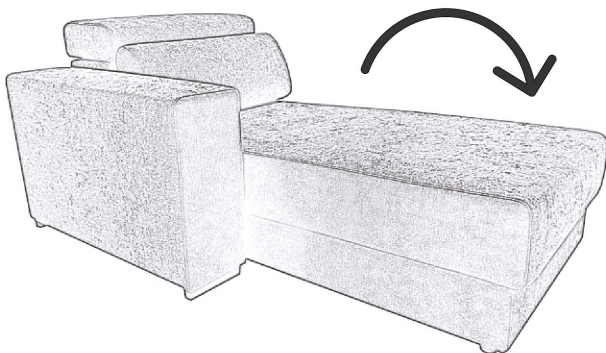
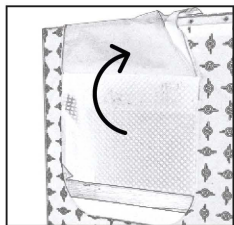

11

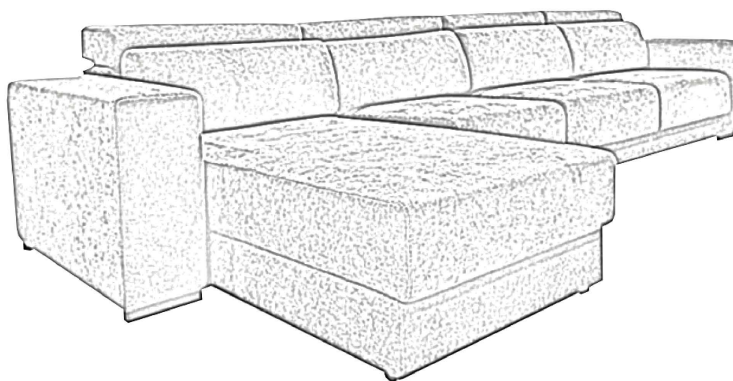
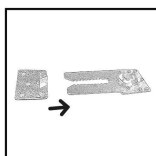
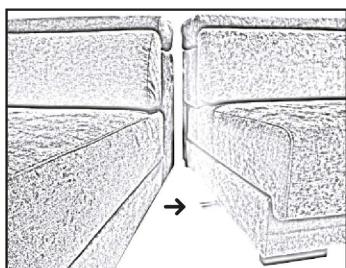



ANTARTE

design for life

SEDE:

AV. DA ZONA INDUSTRIAL, 222

4585-303 REBORDOSA

PAREDES, PORTUGAL

+351 224 119 350

(chamada para a rede fixa nacional)

ANTARTE@ANTARTE.PT

WWW.ANTARTE.PT