

INSTRUÇÕES DE MONTAGEM  
**CABECEIRA EM MADEIRA**  
1600 / 1700 / 1800 / 2000

**DALLAS**

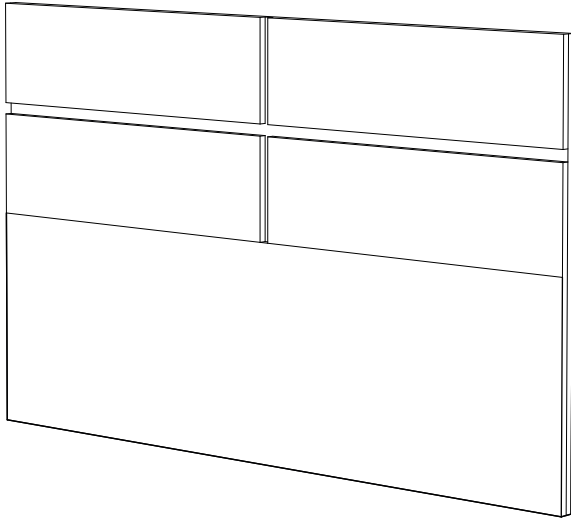

**ANTARTE**

design for life



# Obrigado pela sua preferência!

O design, a elegância e o conforto  
estão agora mais perto de si!



01

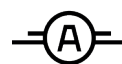
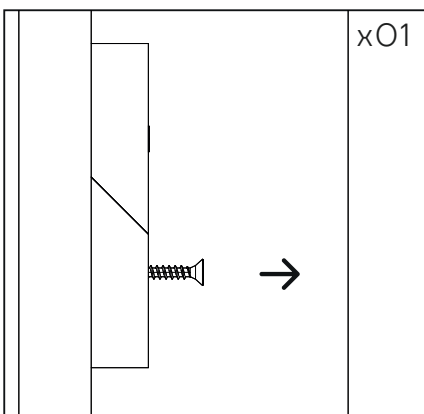
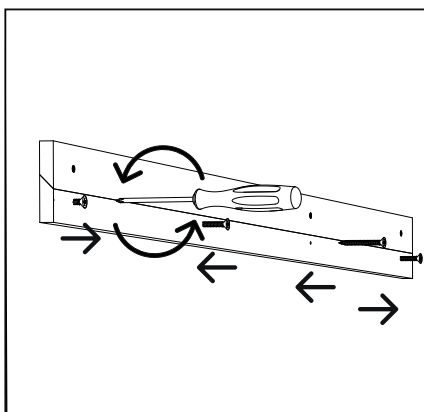
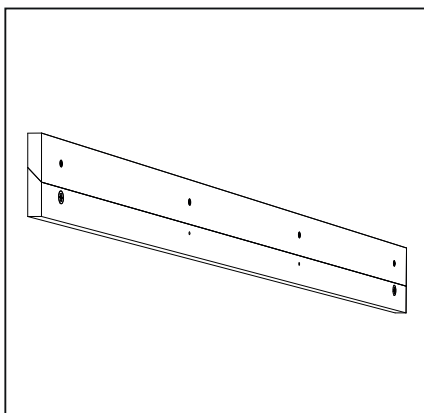

02

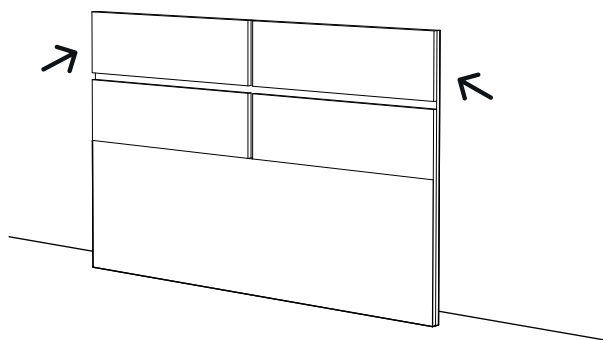
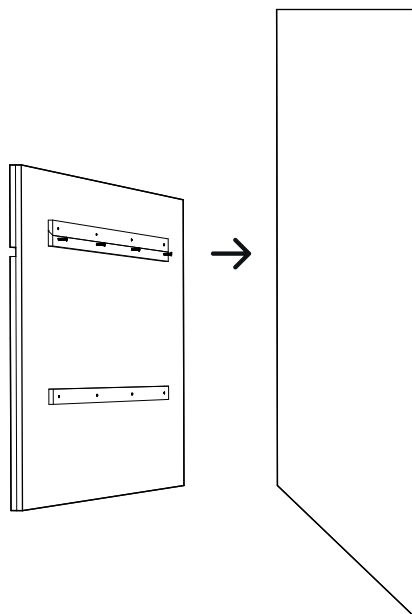

03

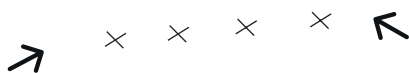
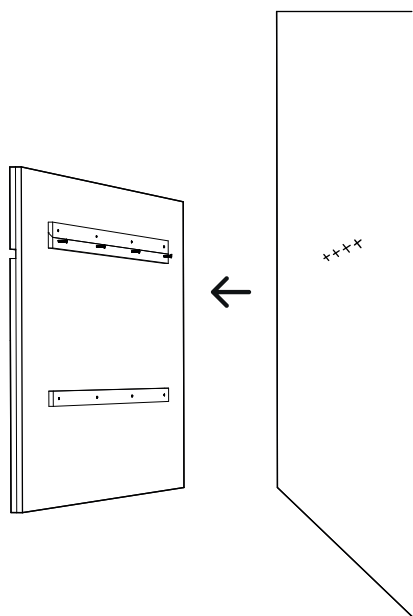

04

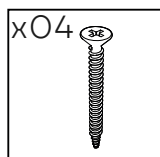
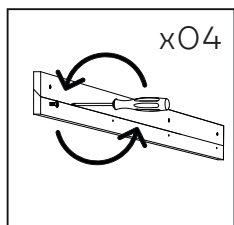
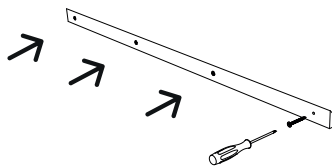

05

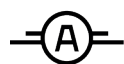
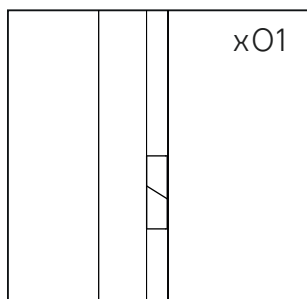
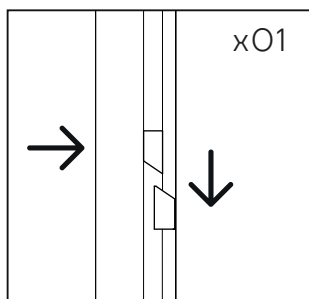
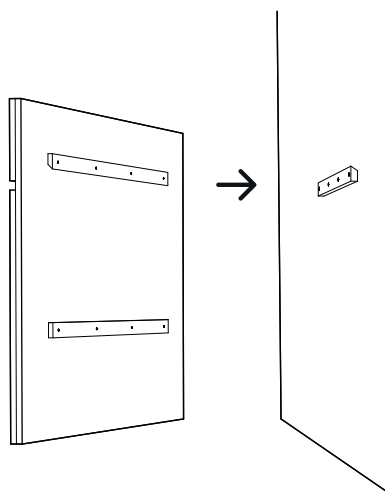

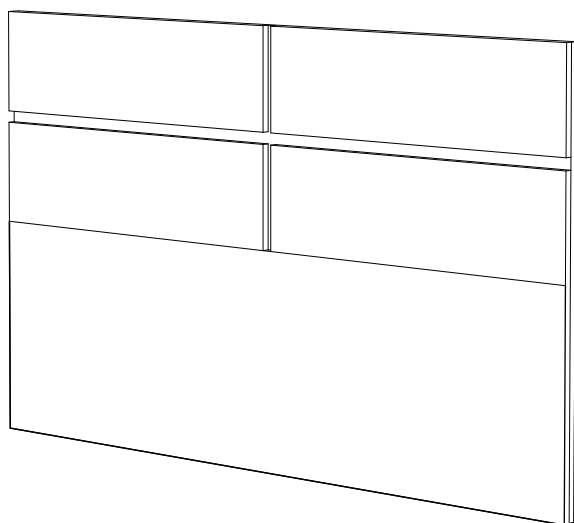



**ANTARTE**

design for life

SEDE:  
AV. DA ZONA INDUSTRIAL, 222  
4585-303 REBORDOSA  
PAREDES, PORTUGAL  
+351 224 119 350  
(chamada para a rede fixa nacional)  
ANTARTE@ANTARTE.PT  
**WWW.ANTARTE.PT**